





ST 010 101 3705



- saillie 160 mm
- bec déverseur fixe
- forme de jet rectangulaire avec 40 jets individuels
- hauteur de robinetterie 108 mm
- hauteur jusqu'au mousseur 94 mm
- diamètre de percement des robinets latéraux 32 mm
- diamètre de percement du bec 35 mm
- 2x flexible de pression M 10 x 1 vissé, étanchéité contrôlée
- débit maxi. 4 l/min
- poignée Ø 60 mm
- sans plomb
- Ce produit contribue au respect des exigences des systèmes d'évaluation des bâtiments écologiques, par exemple LEED®, BREEM®, DGNB

	Platine brossé	ST 010 101 3705-06
	Chrome	ST 010 101 3705-00
	Champagne brossé (Or 22cts)	ST 010 101 3705-46
	Champagne (Or 22cts)	ST 010 101 3705-47
	Dark Platinum brossé	ST 010 101 3705-99

**Composants individuels de ce set**

Ce set requiert les composants suivants

1x 13 714 705-06



1x 20 000 740-06



1x 20 000 741-06











ST 010 101 3705



- saillie 160 mm
- bec déverseur fixe
- forme de jet rectangulaire avec 40 jets individuels
- hauteur de robinetterie 108 mm
- hauteur jusqu'au mousseur 94 mm
- diamètre de percement 35 mm
- 2x flexible de pression M 10 x 1 vissé, étanchéité contrôlée
- raccord 1/2"
- débit maxi. 4 l/min
- sans plomb
- Ce produit contribue au respect des exigences des systèmes d'évaluation des bâtiments écologiques, par exemple LEED®, BREEAM®, DGNB

	Platine brossé	13 714 705-06
	Chrome	13 714 705-00
	Dark Chrome	13 714 705-19
	Champagne brossé (Or 22cts)	13 714 705-46
	Champagne (Or 22cts)	13 714 705-47
	Dark Platinum brossé	13 714 705-99

ST 010 101 3705

mm [inches]

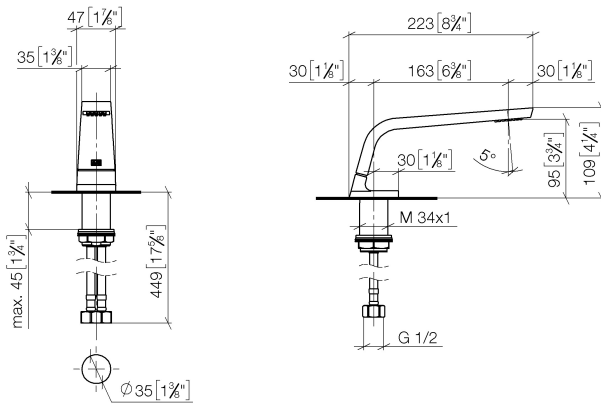

**Diagramme de débit**

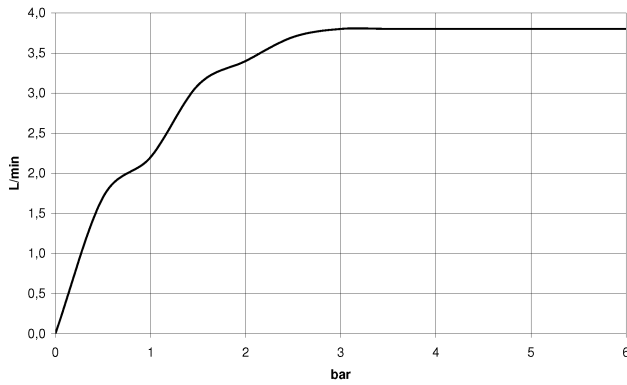

**Certificats**

GDV\_0400279.      LGA\_28686.      IAPMO\_N-4976.      IAPMO\_8834 (1).      IAPMO\_4976 (6).

WRAS\_1512011.      IAPMO\_6397.

ST 010 101 3705

Les pièces pour les autres finitions peuvent être trouvées ici : [Chrome](#)

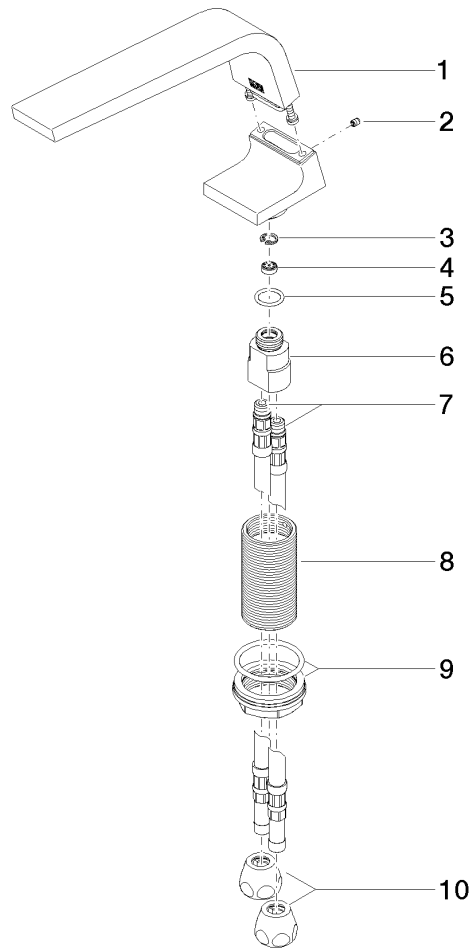

**Liste des pièces de rechange**

N°	Article Numéro	Désignation	Fréquence de montage	Délai de livraison
1	90 11 70 002 00-06	bec déverseur	1	10
2	09 31 11 044 90	tige	1	2
3	09 16 01 016 90	anneau	1	2
4	09 23 01 034 90	limiteur de débit	1	2
5	09 14 10 130 90	joint	1	2
6	09 11 10 055 10 90	raccord	1	2
7	04 30 04 016 00 90	flexible	2	60
8	09 30 01 208 90	raccord	1	2
9	04 23 10 044 06 90	set de fixation	1	2
10	90 23 30 040 00-06	joint américain	2	10

ST 010 101 3705

- diamètre de percement 32 mm
- poignée Ø 60 mm
- sans rosace
- avec marquage froid



S'adapte aux gammes suivantes : CL.1, CYO

	Platine brossé	20 000 740-06
	Chrome	20 000 740-00
	Platine	20 000 740-08
	Dark Chrome	20 000 740-19
	Laiton brossé (Or 23cts)	20 000 740-28
	Noir mat	20 000 740-33
	Champagne brossé (Or 22cts)	20 000 740-46
	Champagne (Or 22cts)	20 000 740-47
	Dark Platinum brossé	20 000 740-99



ST 010 101 3705

mm [inches]

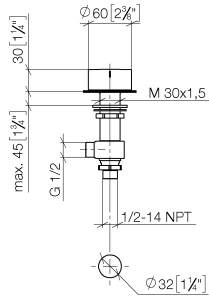

**Diagramme de débit**

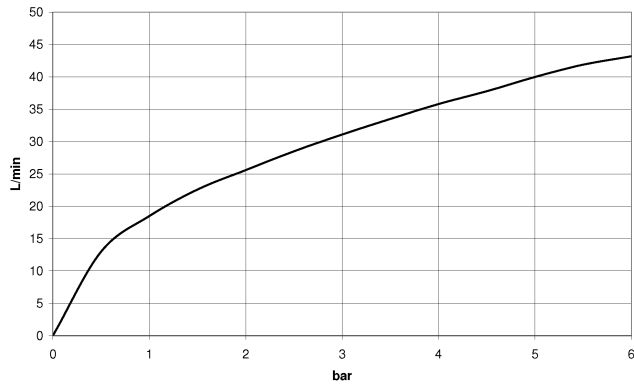

**Certificats**

IAPMO\_4976 (5). WRAS\_2103001. LGA\_28688.



ST 010 101 3705

Les pièces pour les autres finitions peuvent être trouvées ici : [Chrome](#)

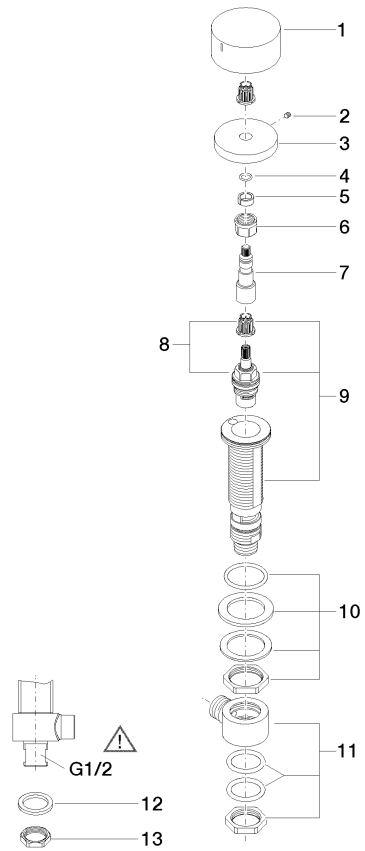

**Liste des pièces de rechange**

N°	Article Numéro	Désignation	Fréquence de montage	Délai de livraison
1	09 20 74 005-06	poignée ( cold )	1	60
2	90 31 11 007 00 90	tige	1	2
3	09 27 74 003-06	rosace	1	10
4	90 14 10 060 00 90	joint	1	2
5	90 14 15 020 03 90	anneau	1	2
6	90 23 30 023 00 90	écrou	1	2
7	09 29 06 107-00	tige	1	10
8	90 90 03 133 00 90	tête céramique	1	2
9	04 17 11 058 33 90	partie latérale	1	2
10	04 23 10 032 78 90	set de fixation	1	2
11	04 17 11 023 10 90	raccord multiple	1	2
12	09 30 11 059 90	rondelle	1	2
13	09 23 10 012 90	écrou	1	2

ST 010 101 3705

- diamètre de percement 32 mm
- poignée Ø 60 mm
- sans rosace
- avec marquage chaud



S'adapte aux gammes suivantes : CL.1, CYO

	Platine brossé	20 000 741-06
	Chrome	20 000 741-00
	Dark Chrome	20 000 741-19
	Laiton brossé (Or 23cts)	20 000 741-28
	Noir mat	20 000 741-33
	Champagne brossé (Or 22cts)	20 000 741-46
	Champagne (Or 22cts)	20 000 741-47
	Dark Platinum brossé	20 000 741-99



ST 010 101 3705

mm [inches]

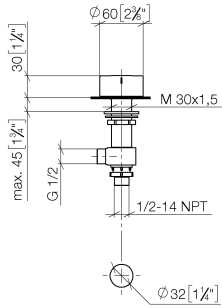

**Diagramme de débit**



**Certificats**

IAPMO\_4976 (5). WRAS\_2103001. LGA\_28688.

ST 010 101 3705

Les pièces pour les autres finitions peuvent être trouvées ici : [Chrome](#)

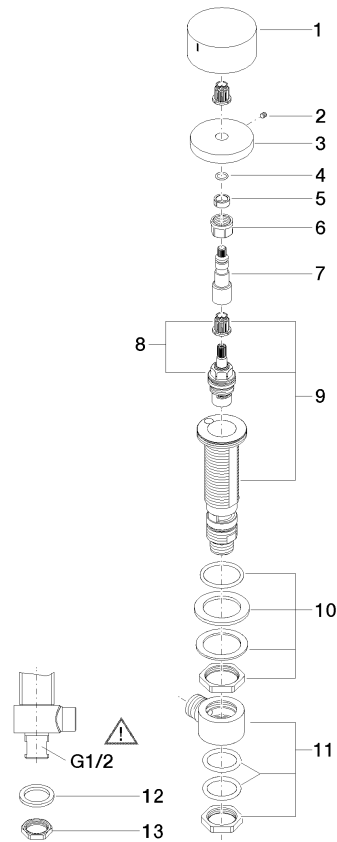

### Liste des pièces de rechange

N°	Article Numéro	Désignation	Fréquence de montage	Délai de livraison
1	09 20 74 006-06	poignée ( hot )	1	10
2	90 31 11 007 00 90	tige	1	2
3	09 27 74 003-06	rosace	1	10
4	90 14 10 060 00 90	joint	1	2
5	90 14 15 020 03 90	anneau	1	2
6	90 23 30 023 00 90	écrou	1	2
7	09 29 06 107-00	tige	1	10
8	90 90 03 132 00 90	tête céramique	1	2
9	04 17 11 058 32 90	partie latérale	1	2
10	04 23 10 032 78 90	set de fixation	1	2
11	04 17 11 023 10 90	raccord multiple	1	2
12	09 30 11 059 90	rondelle	1	2
13	09 23 10 012 90	écrou	1	2